

# Workshop Images

## 3DMPC

### SWITCHES + SENSORS

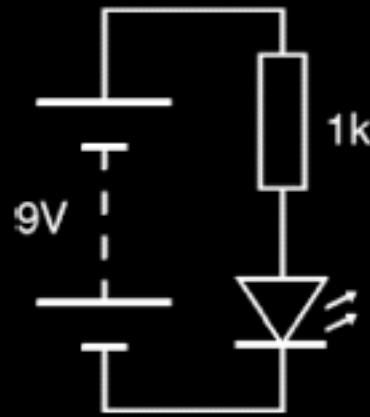

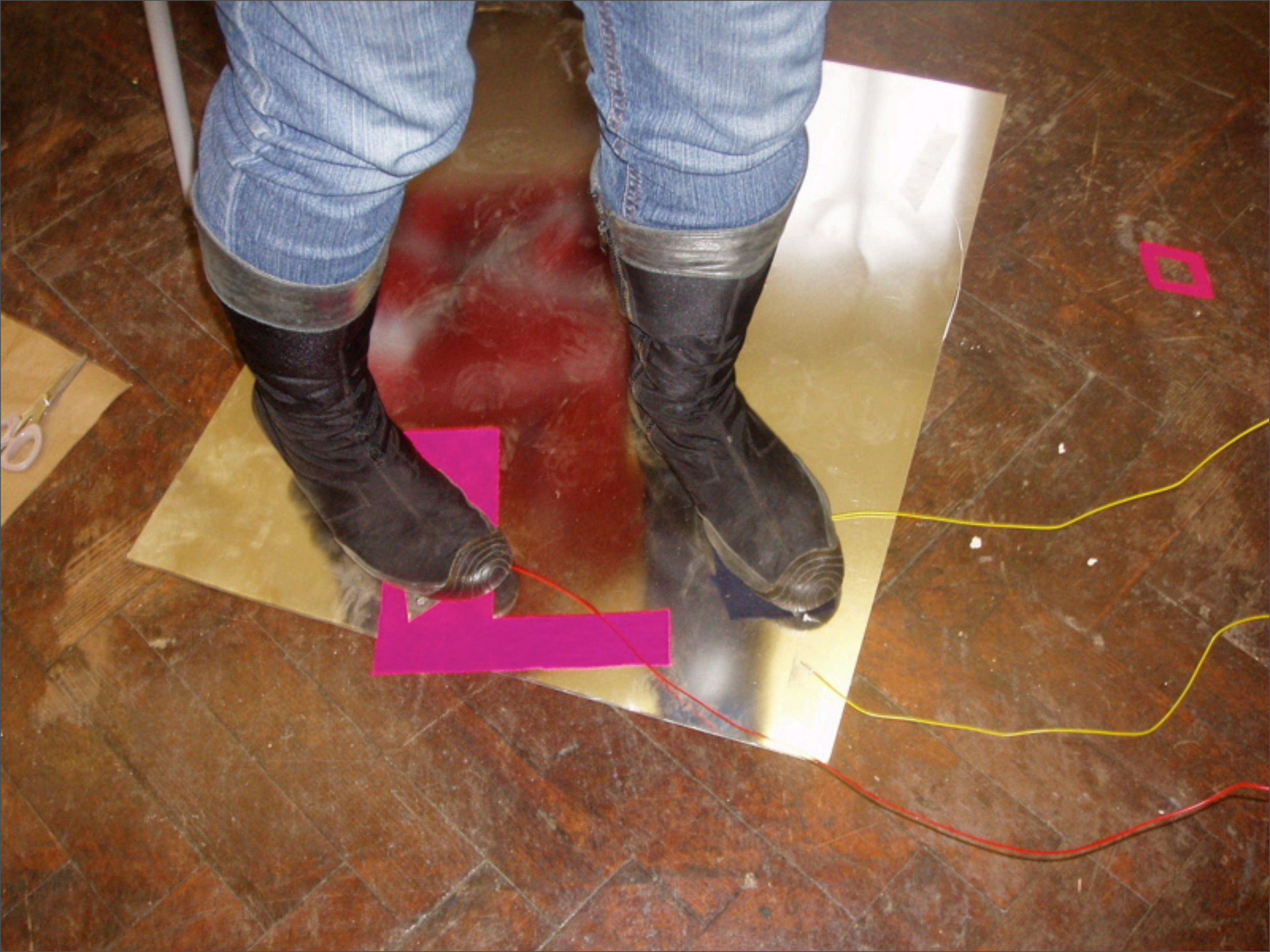

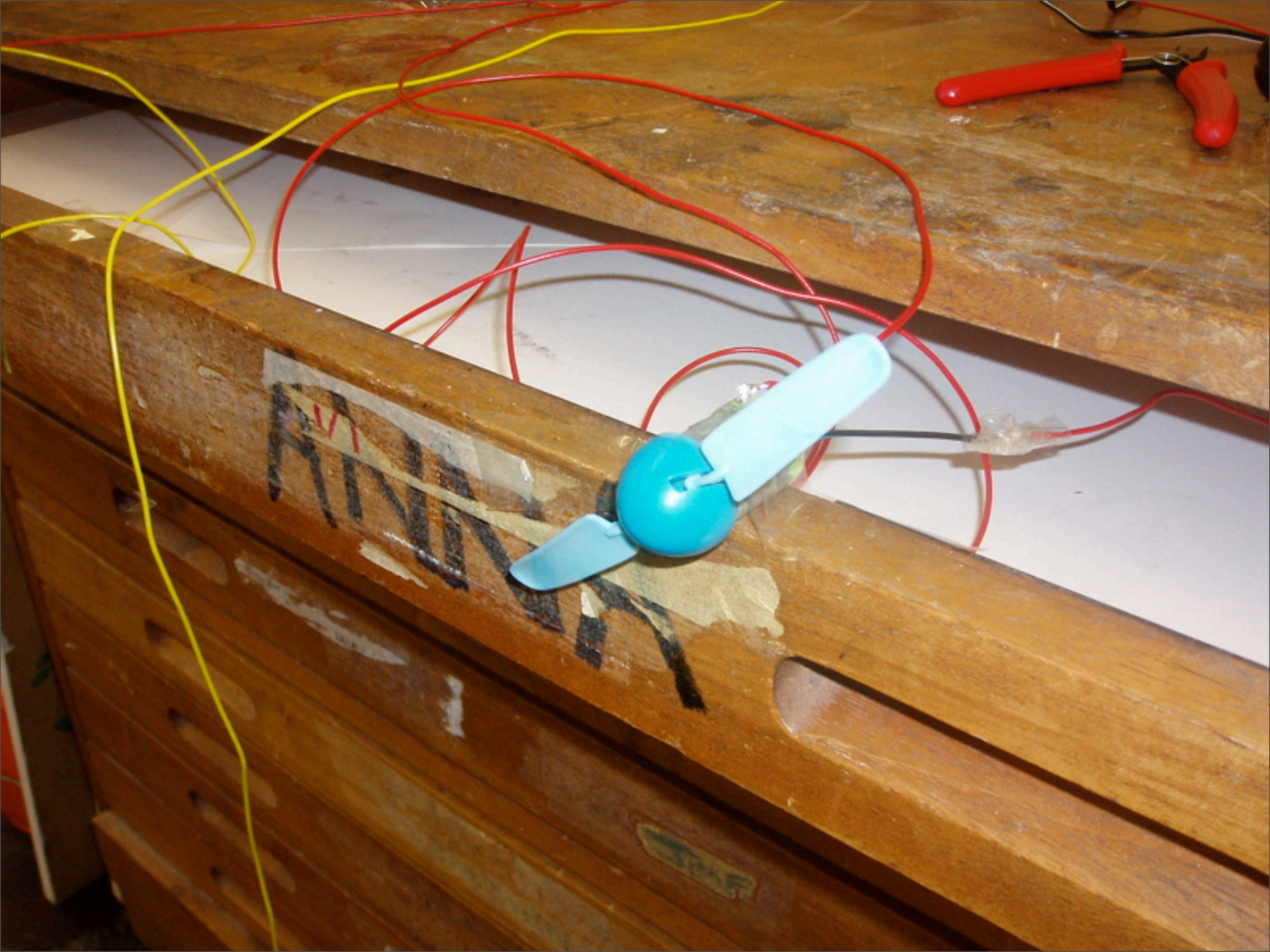

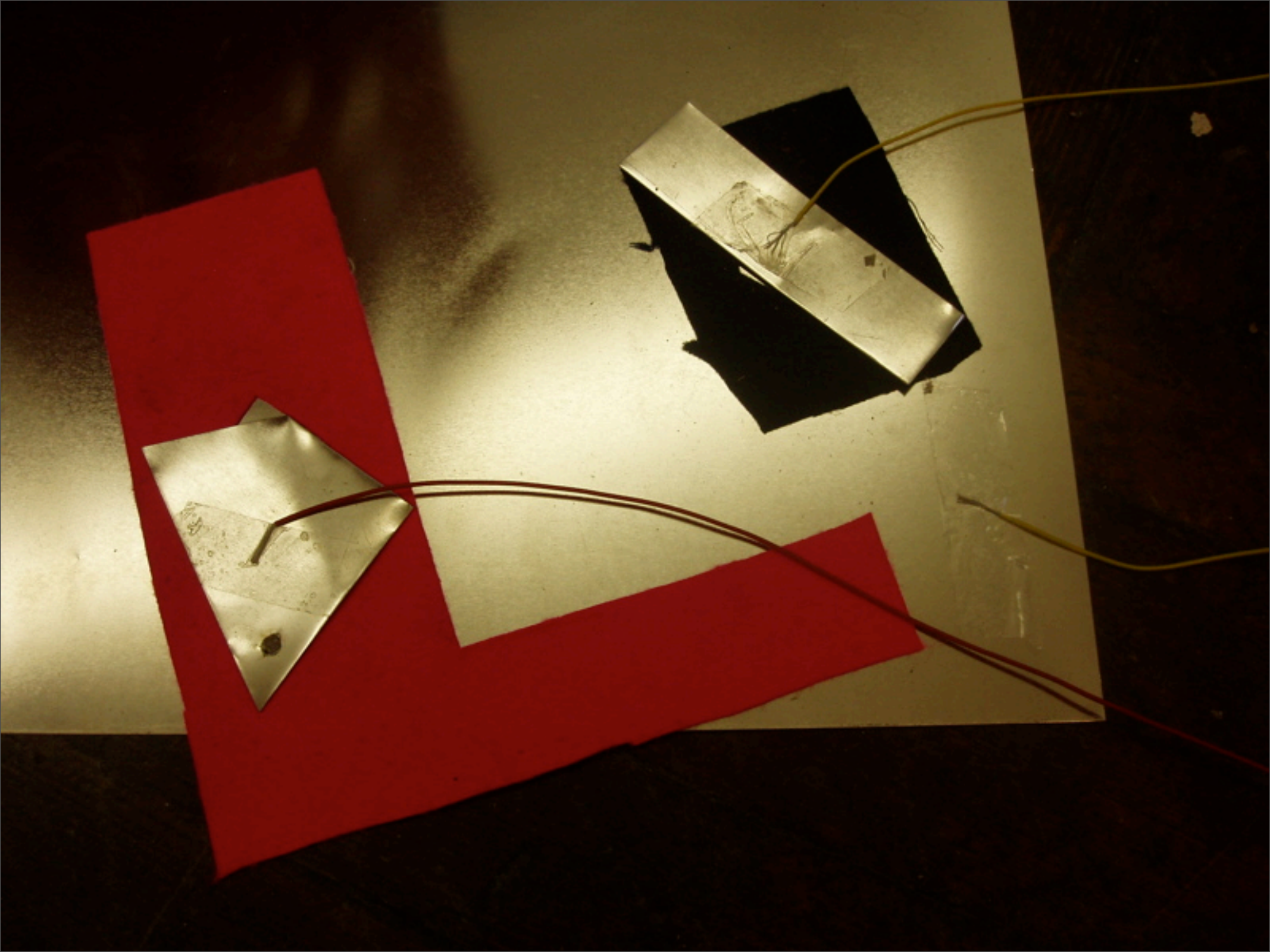

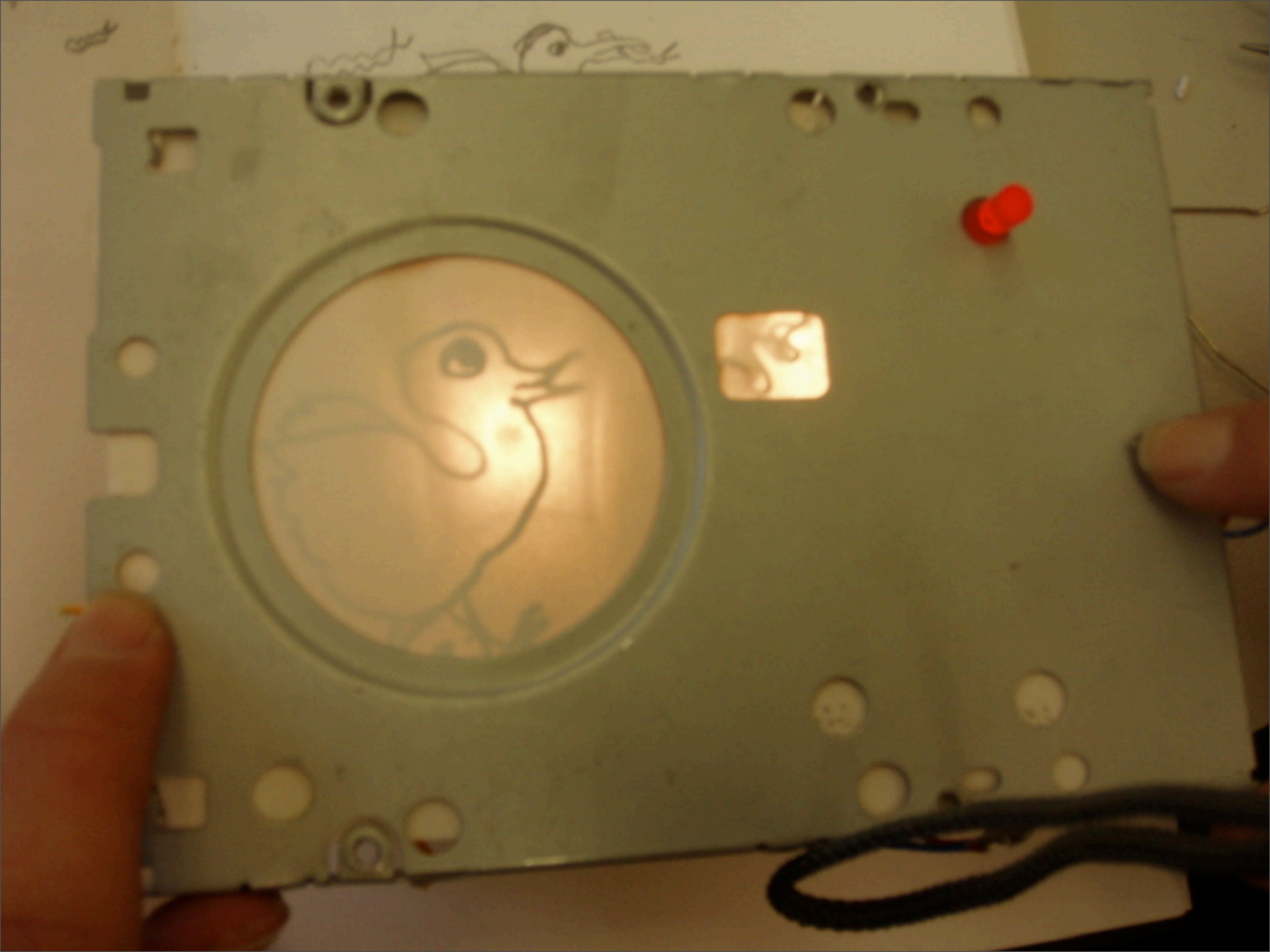

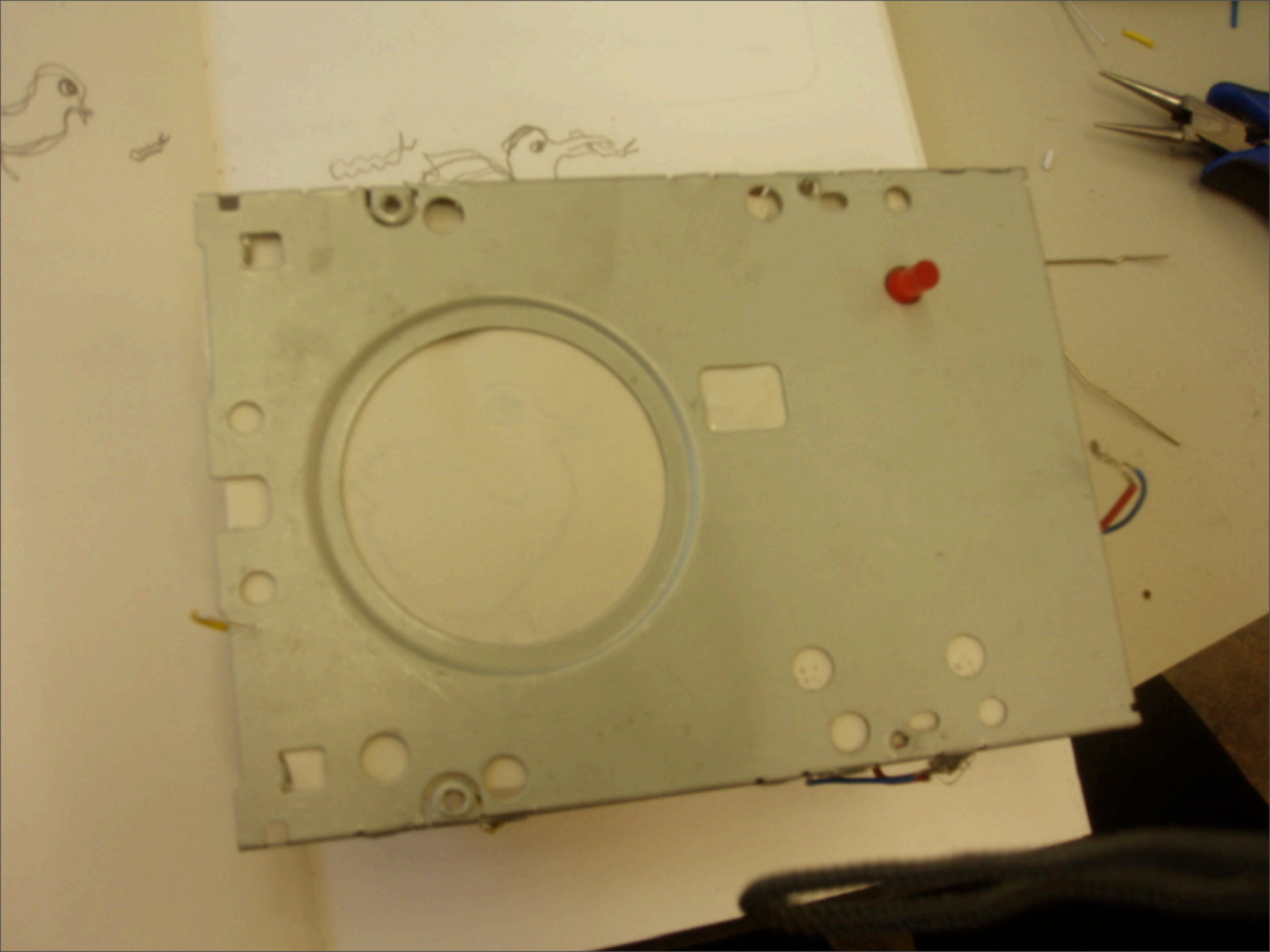

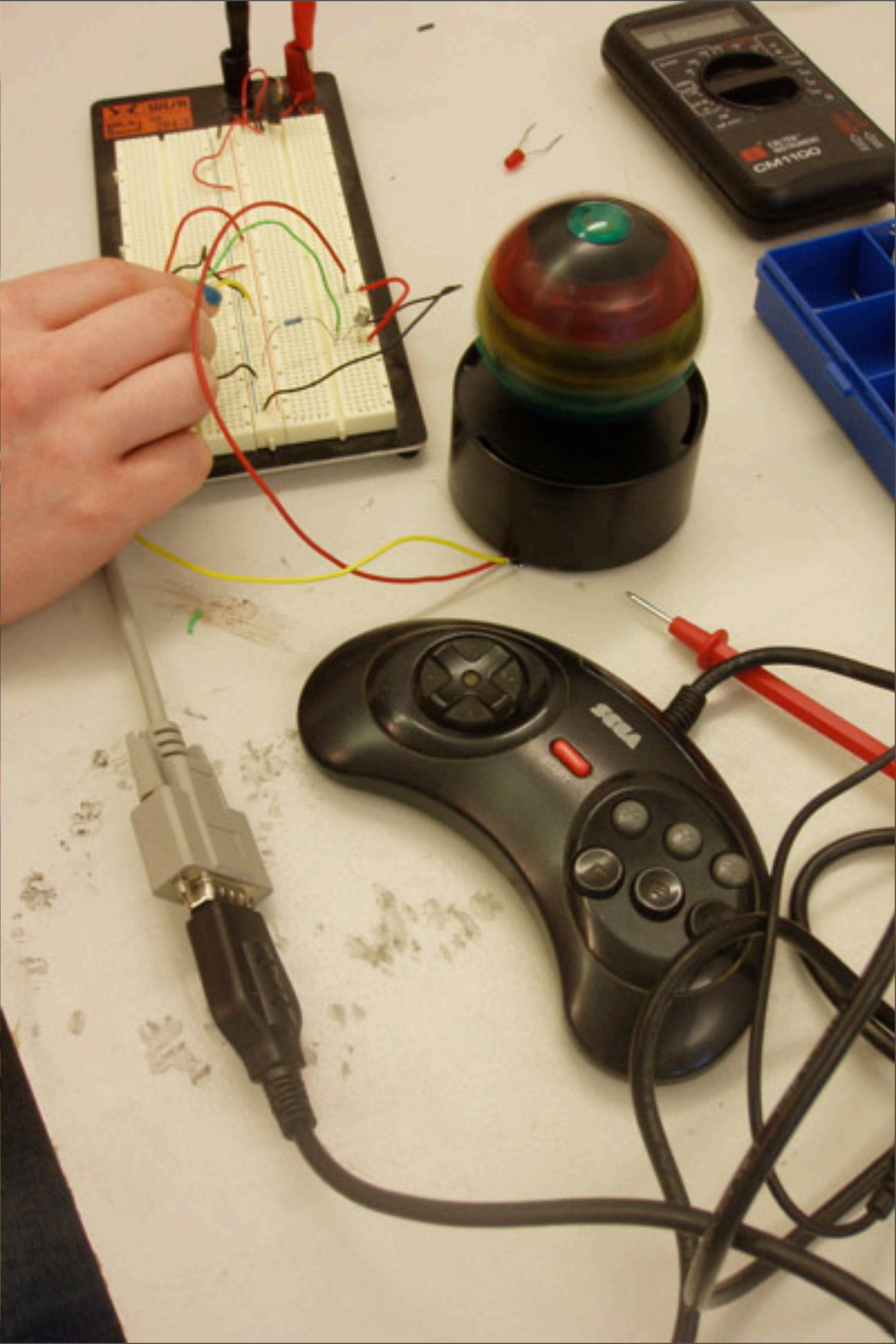
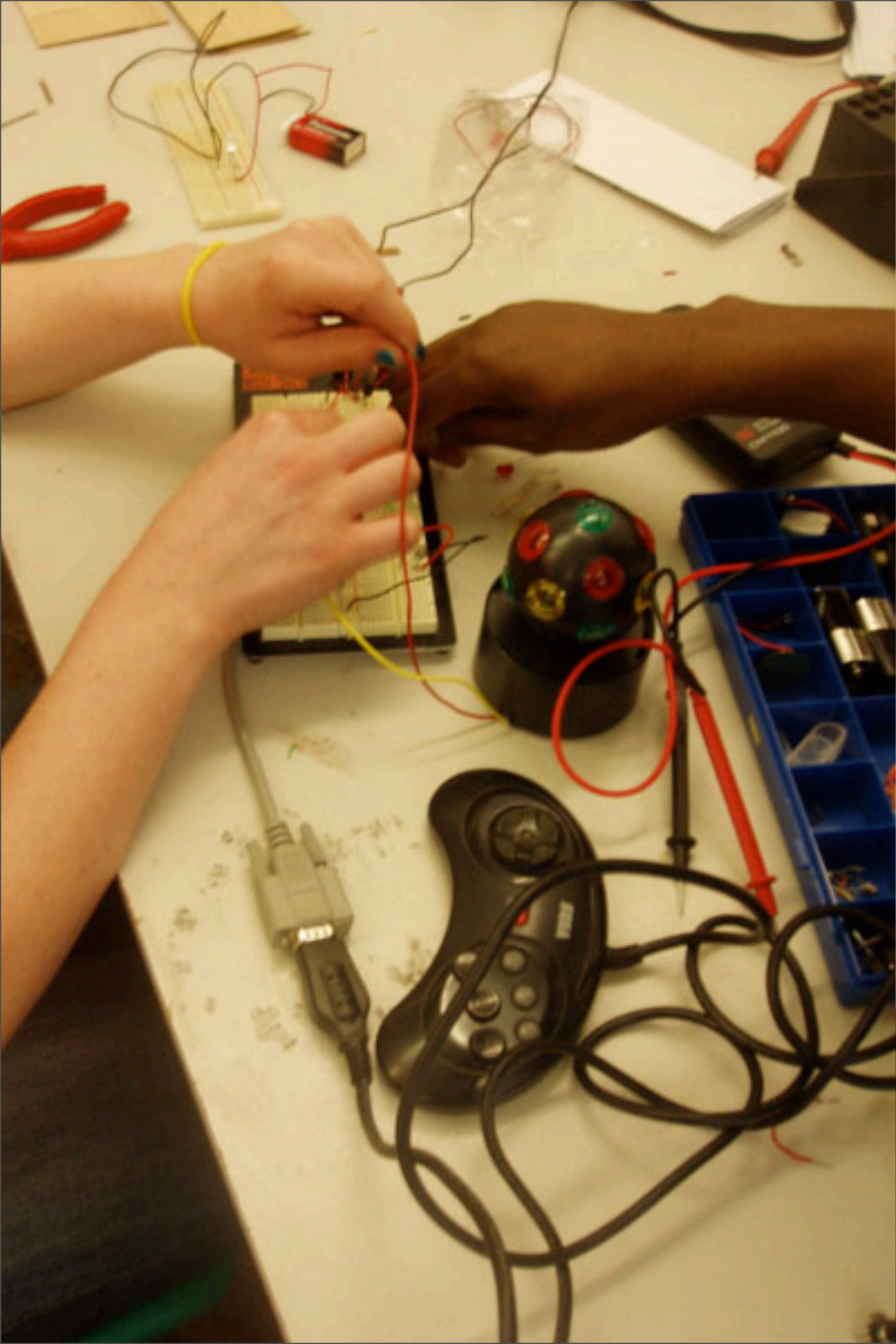

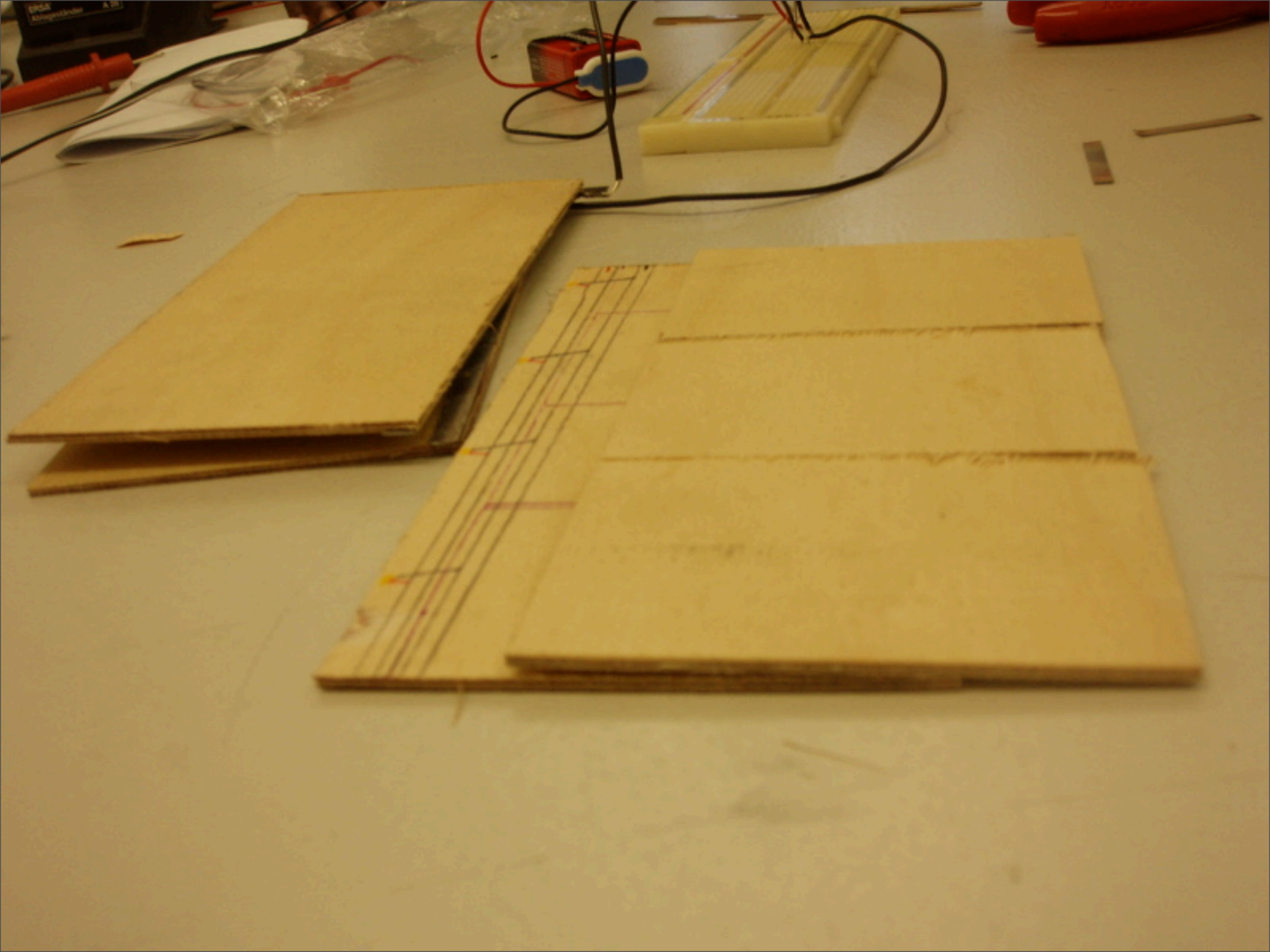

## My Game Controller



### Details

- Competition Pro Professional Control Pad for use w/IBM PCs and compatibles
- 4 fire/action buttons
- 8 way super switch
- selectable button configurations for single shot and/or turbo fire

### Color Code (I think)

- Blue — Left
- Green — Up
- Red — Right/Down?
- Black — Grounding
- White — B
- Orange — C
- Brown — A
- Yellow — D





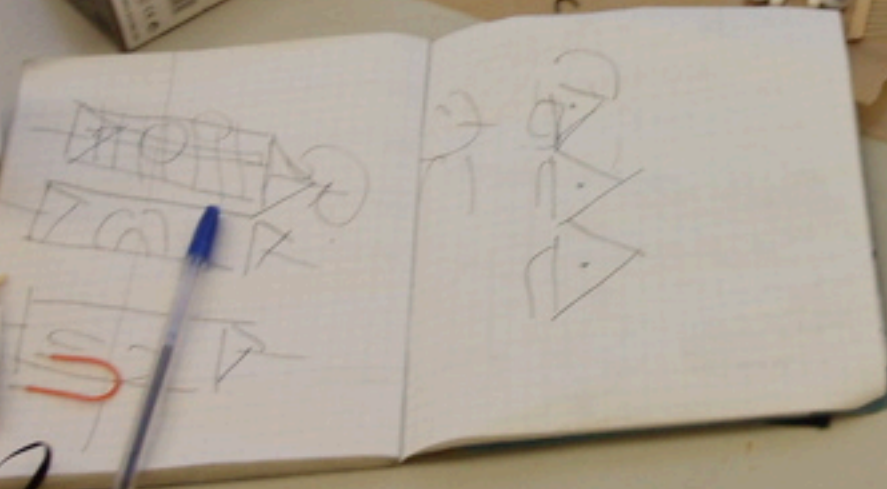
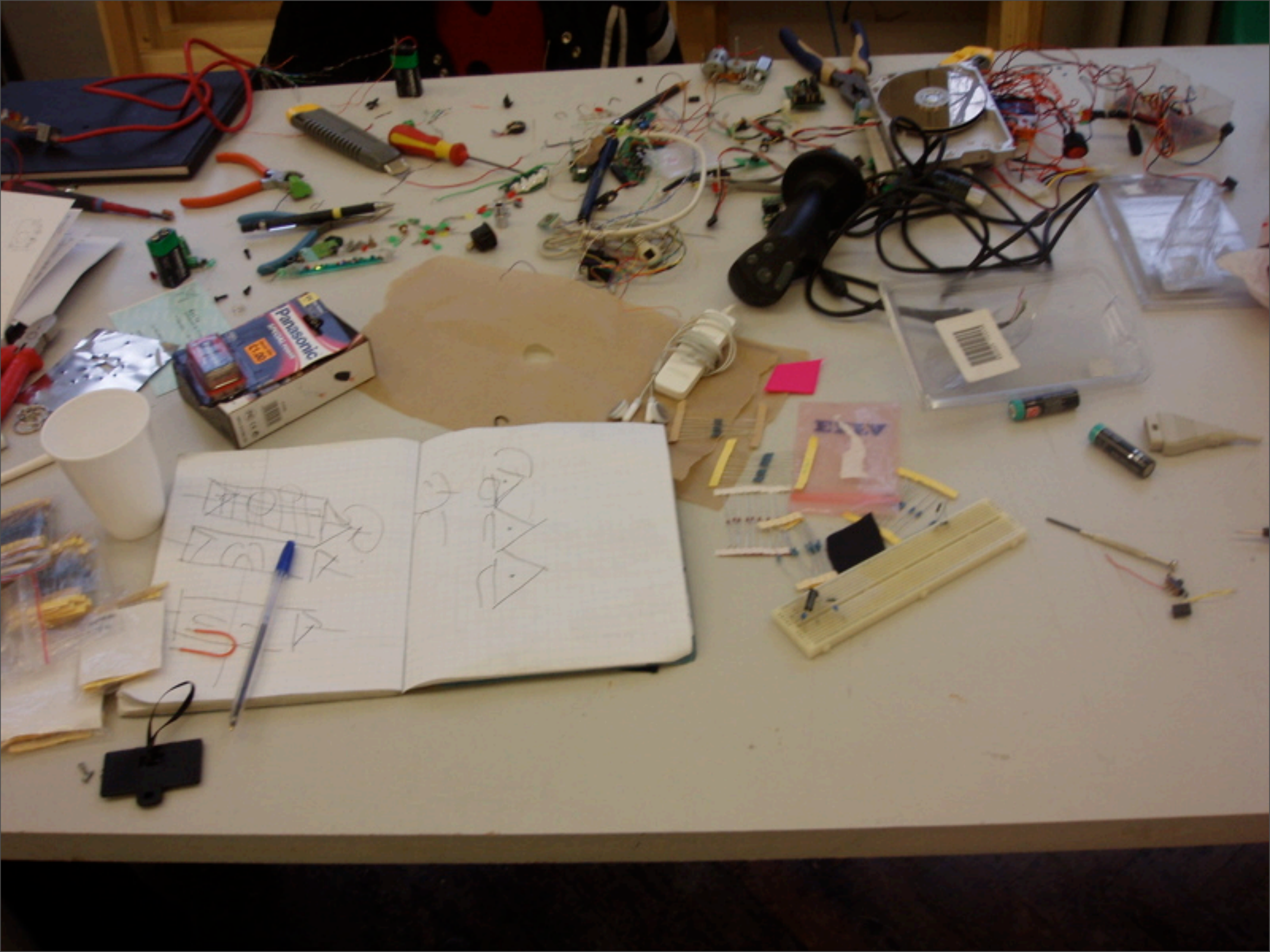

Panasonic  
1.5V  
LR6  
AAA

